

12" Wide Plastic Lockers – 95000 Series

Five Tier Installation Instructions

Thank you for selecting Salsbury's 95000 series 12" wide five tier plastic lockers. We are confident that the quality and construction of the lockers will prove to be a good investment. These instructions are intended to assist you in the assembly of the lockers. Individual job conditions will dictate whether the lockers must be anchored to the wall, the floor, or both. **Please read the entire assembly instruction document before beginning assembly.**

Step 1. Insert the back panel tabs into the pockets along the rear edge of the side panel. Tap with soft mallet to engage two (2) latch points.



Step 2. Press another side panel onto the tabs on the other side of the back panel. Tap to engage as above.

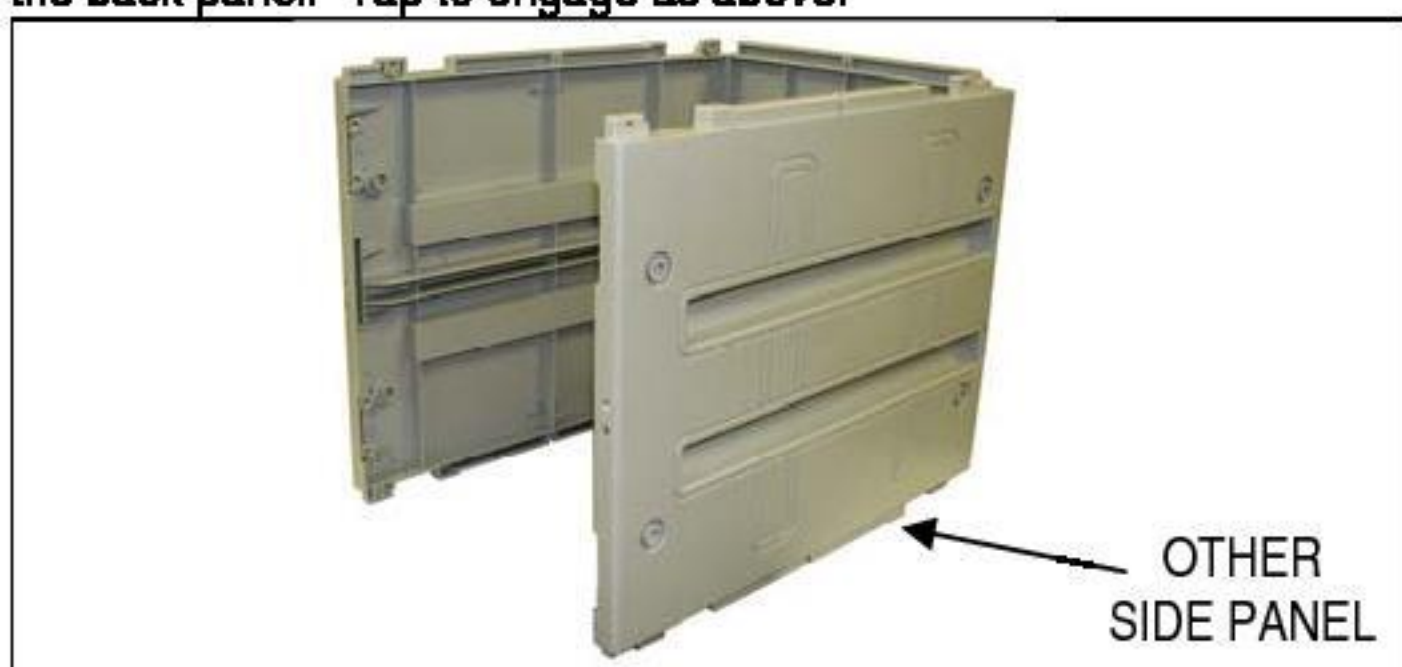

Step 3. Join and press down the sides-and-back-panel assembly from step 2 above into the base panel as shown below. The base panel is the thicker of the six (6) horizontal panels provided. Then thread four (4) leveling feet provided into the bottom of the base panel.



Step 4. Install a thinner top horizontal panel on top of the unit.



Step 5. Assemble four (4) identical units the same as Steps 1 through 4, except installing the thinner top panel on each instead of the thicker base panel. These units will not have leveling feet.



Step 6. If no optional sloping hood is ordered, install the three (3) filler strips into the recesses in the top panel of one (1) of the upper units. This will be the uppermost unit after the units are stacked.



12" Wide Plastic Lockers – 95000 Series

Five Tier Installation Instructions

Step 7. Stack the four (4) upper units onto the lower unit. Press all units firmly together. Use a mallet if necessary.

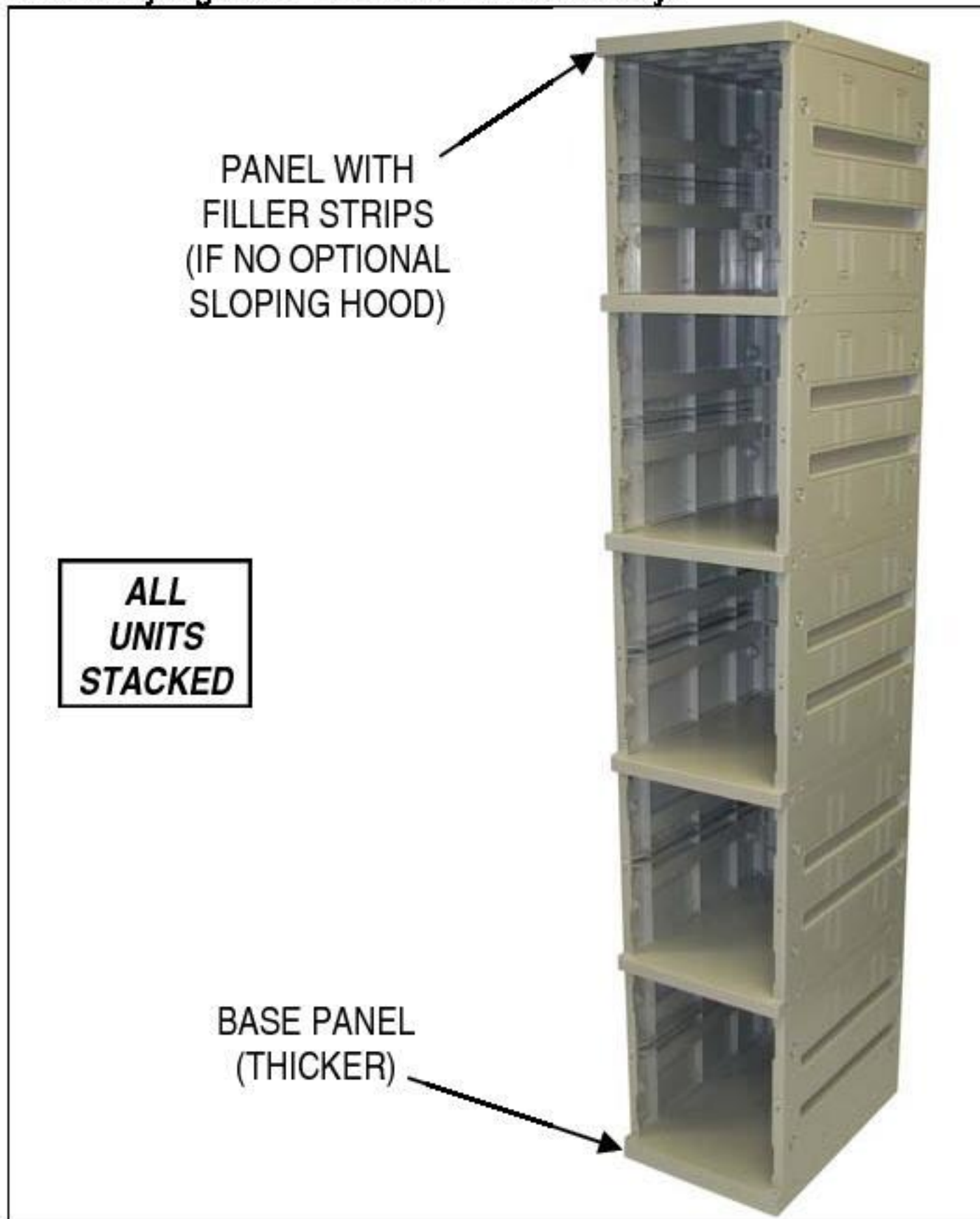

Step 8. Install screws and hole covers where side panels join to top panels and base panel. There are 22 screws and hole covers on each of the two sides of the assembly (44 in total).

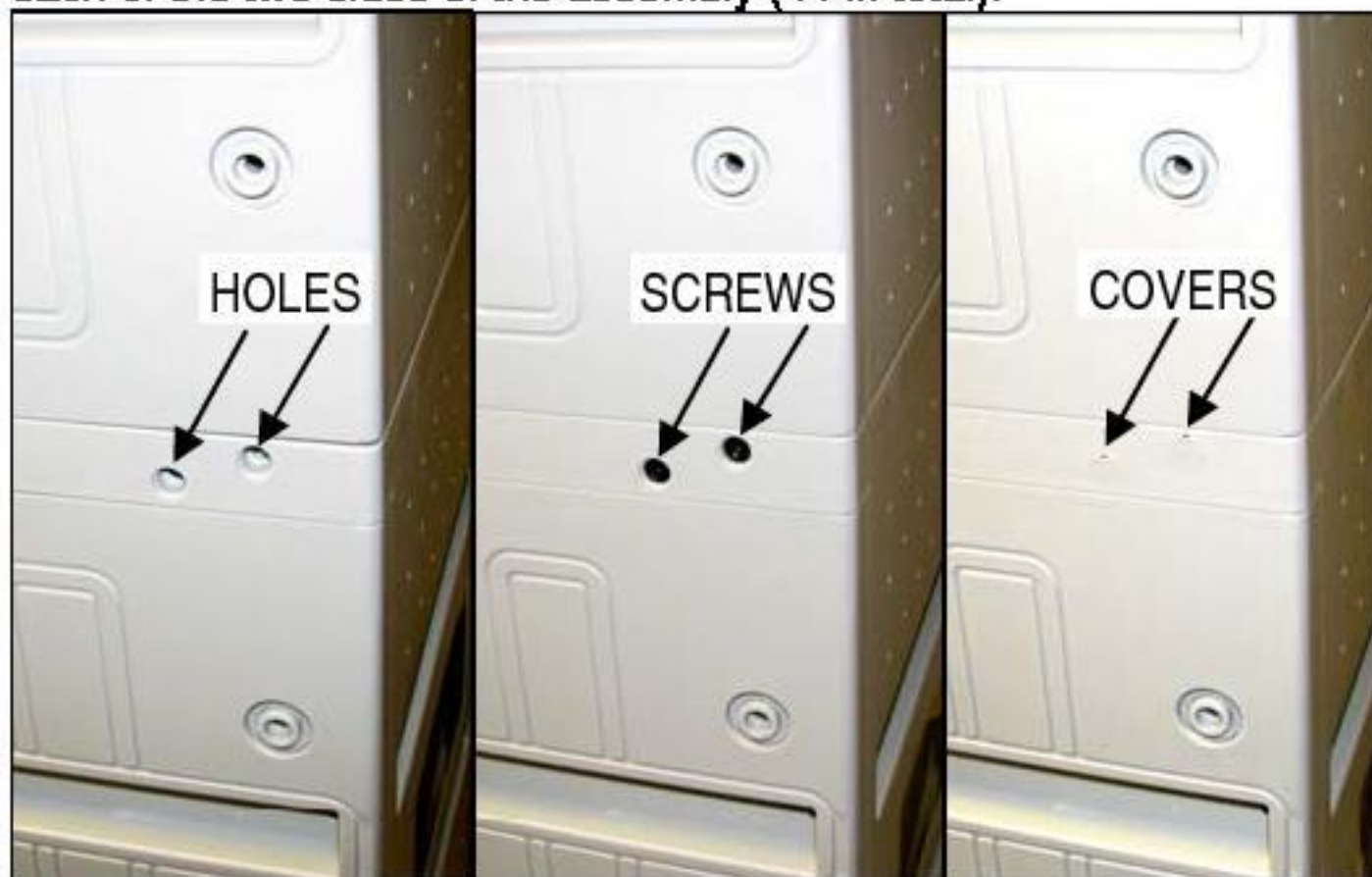

Step 9. Attach the plastic oval lock plate to the front of the five (5) doors with two (2) screws from the rear of the door. Insert the stainless steel hasp through hole in front of doors making sure cutout is facing downward. Secure by threading nut provided onto it from rear. Insert lock knob through hasp from front of door making sure hole in lock knob is facing downward. Attach cam to rear of lock knob shaft with screw provided. Be sure the cam is pointing toward the outside of the door and is properly engaged with the square shaft end of the lock knob.

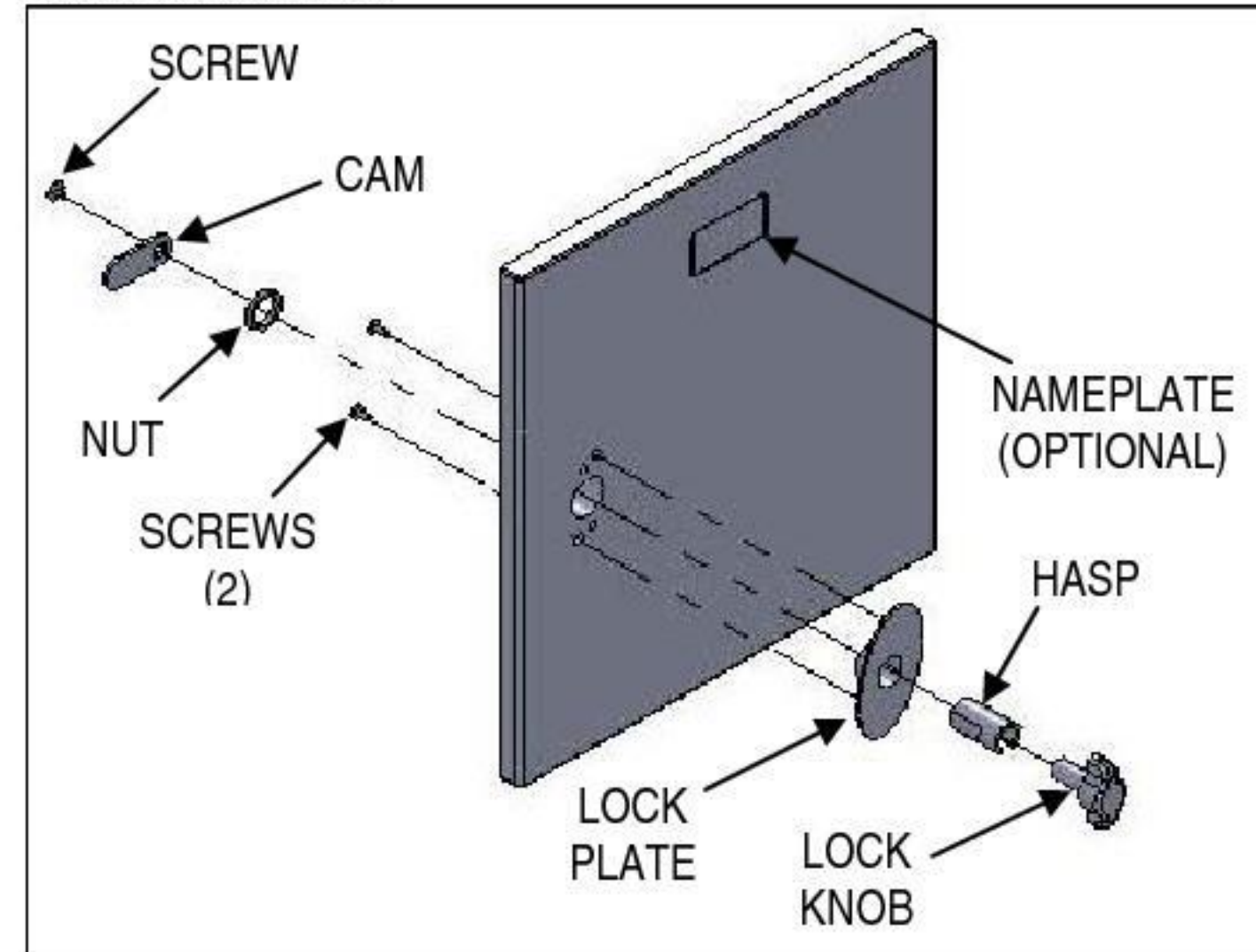

Step 10. Fasten the ten (10) hinges (two (2) for each of the five (5) doors) provided in the hardware package securely to each hinge position with the screws provided as shown below. Fasten each of the five (5) doors to the appropriate pair of hinges.

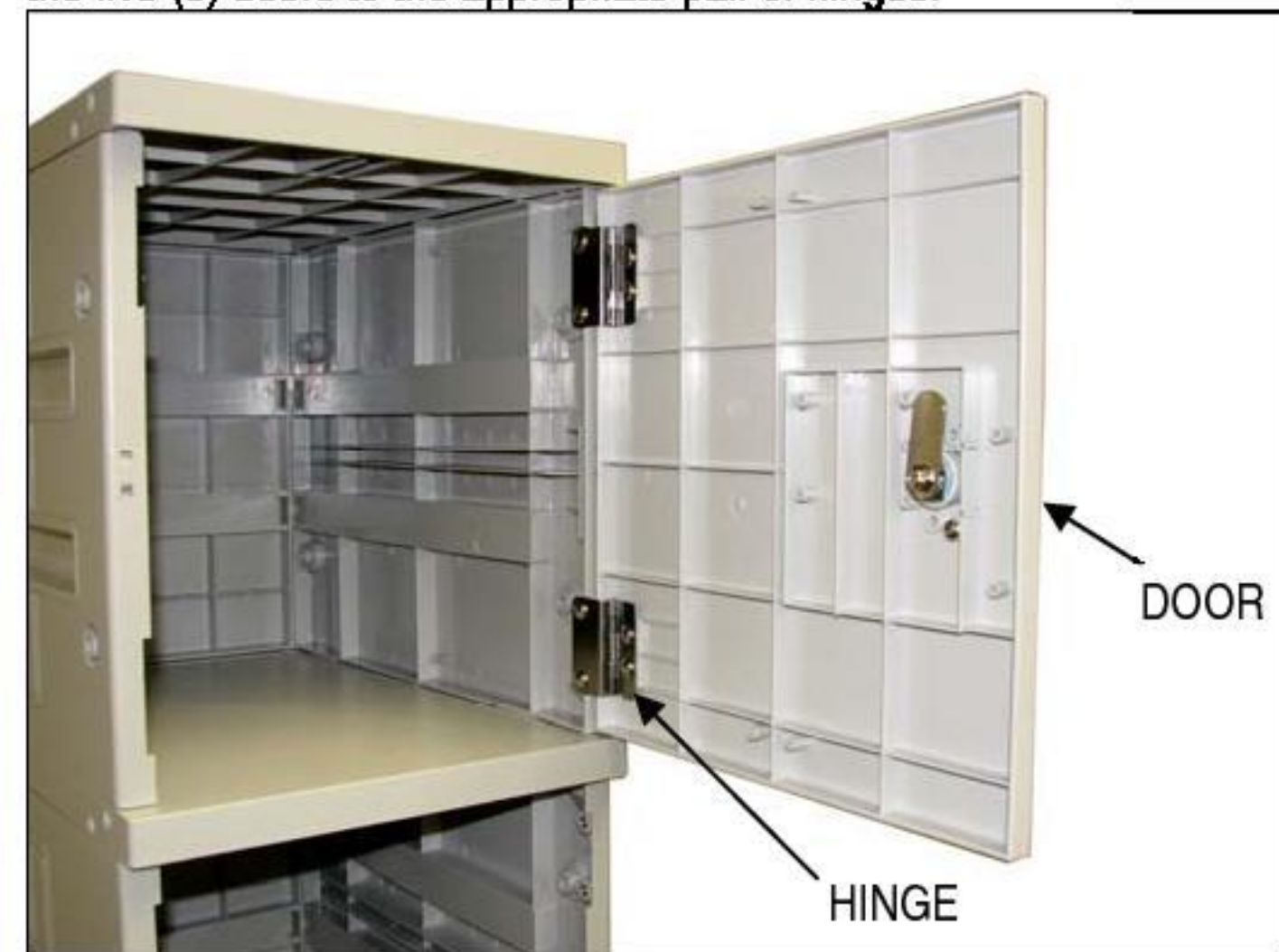

12" Wide Plastic Lockers – 95000 Series

Five Tier Installation Instructions

Step 11. Slide the shelves (optional) into the slots in the locker side panels. There is one slot available for a shelf in each of the five (5) compartments.

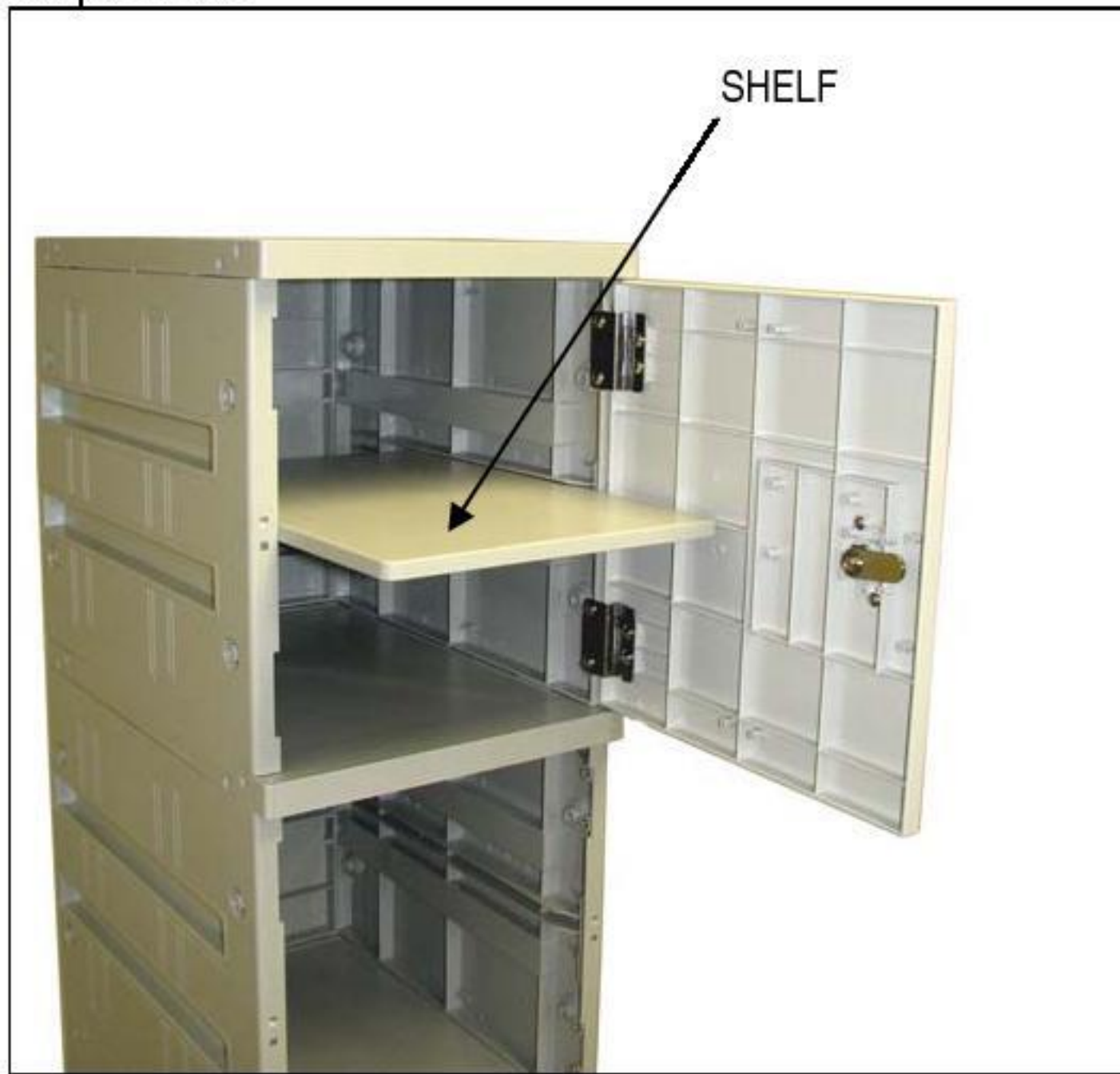

Step 12. Install the sloping hood (optional) to the top of each locker column by aligning six (6) locating tabs with the topmost panel. Press locating tabs into place. Illustration shows sloping hood before pressing tabs into place. Plastic filler strips shown in step 6 are not required on units with a sloping hood and can be discarded.

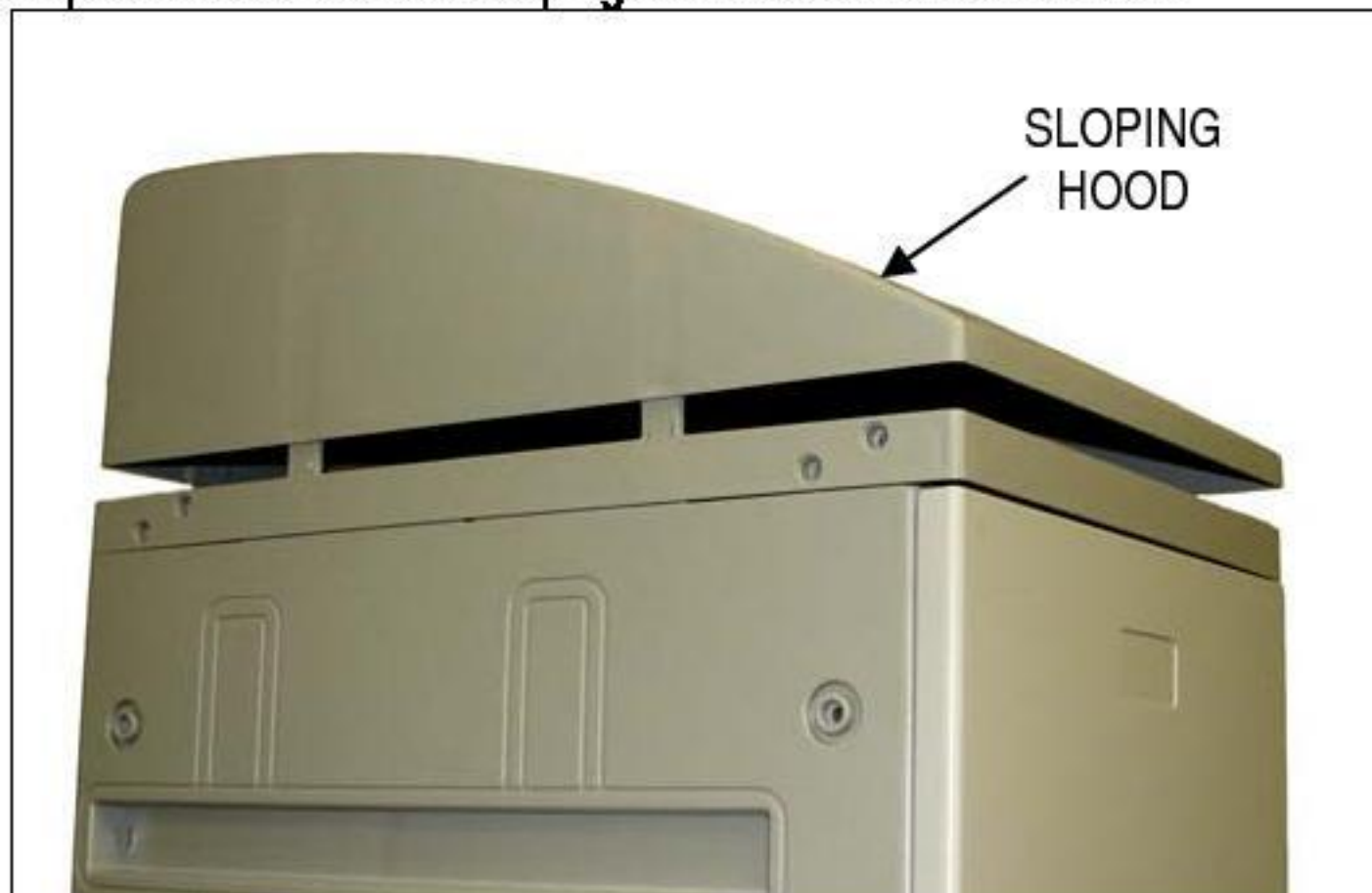

Step 13. Install placards (optional) in the indentation near the top of each door.

Step 14. If two (2) or more lockers are to be installed side by side, the lockers should be fastened together with the four (4) nuts and long screws provided. Select any two (2) holes toward the front and any two (2) holes toward the rear. The illustration below shows the 20 holes that are available. The lower illustration shows the inside view of a hole and screw.



The assembly of the plastic lockers is now complete.