

Pullout Keyboard Shelf Instructions

for Plastic Carts

08/06/13

Parts List

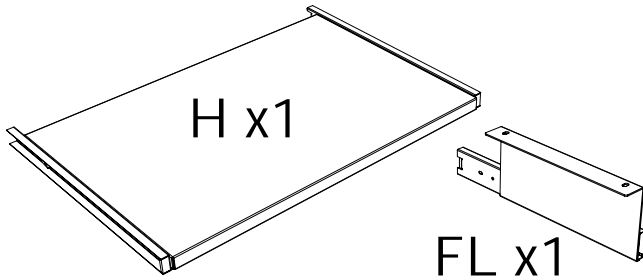

Tools Required

- Phillips Screwdriver



NOTICE:
Size and style of the plastic ribbed shelf may vary by model number.

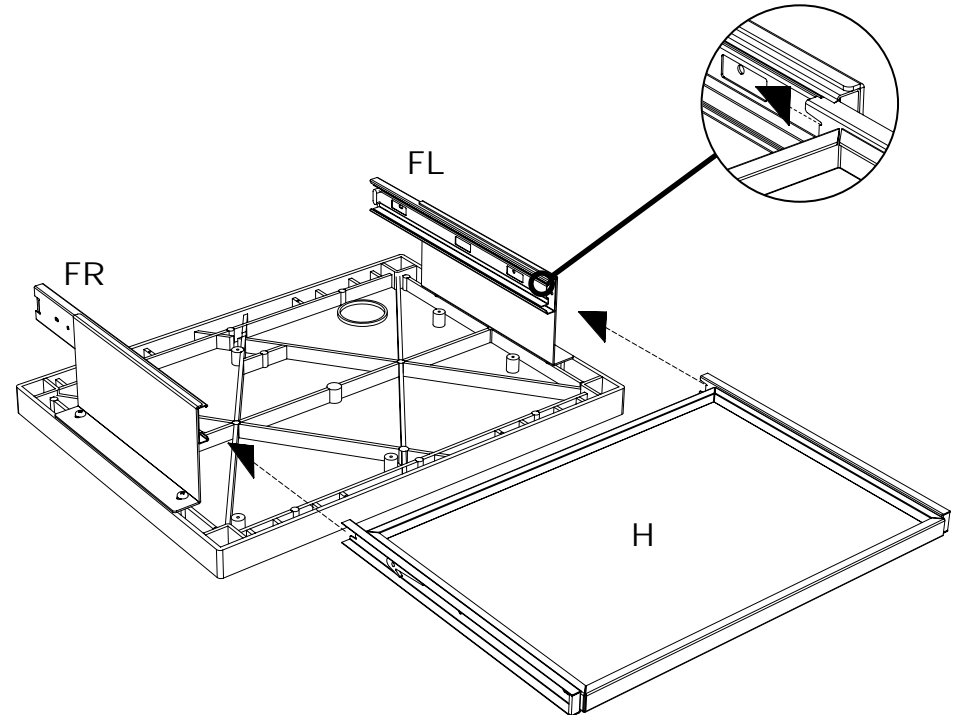
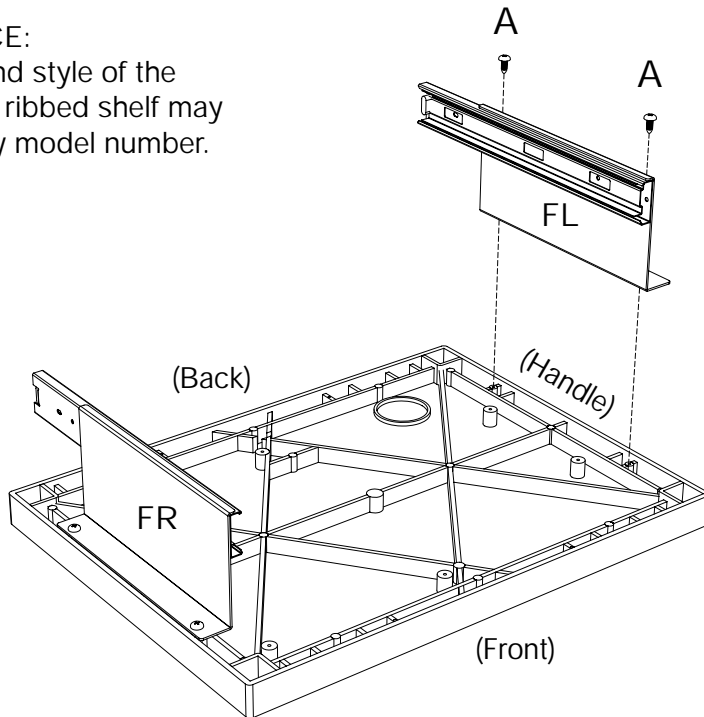

STEP 1

FL, FR & A. Align FR & FL to the outer holes at the top of the shelf. Take screw A and fasten with a screwdriver, do not tighten fully until keyboard is attached.

STEP 2

Align the pullout shelf H runner so that the runner snaps into place into the FL & FR brackets. Pull the shelf out to make sure it is fully seated. Tighten screws A. Pullout keyboard shelf assembly is now complete.

Electric Assembly Instructions

03/31/15

Number of outlets
may vary.

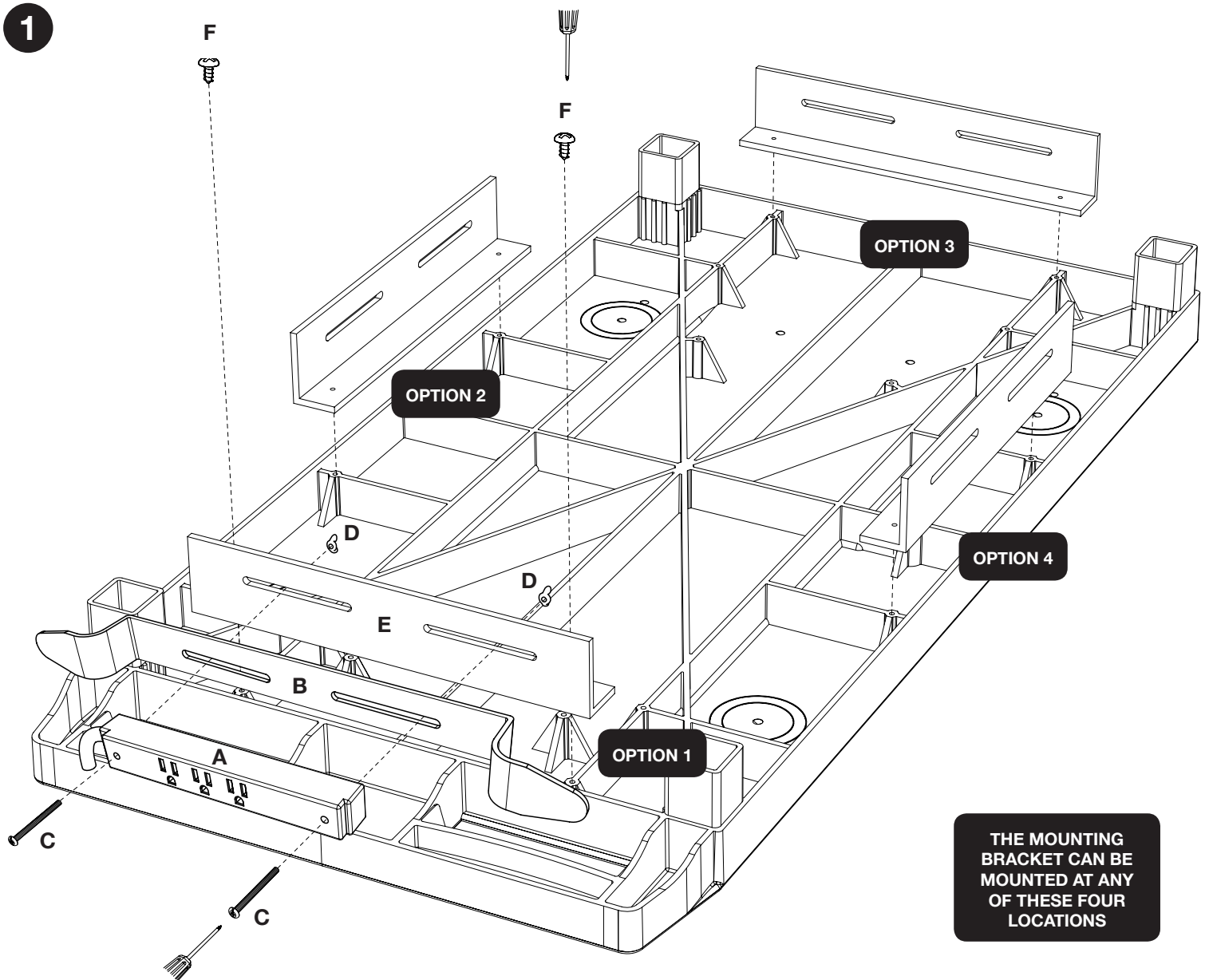
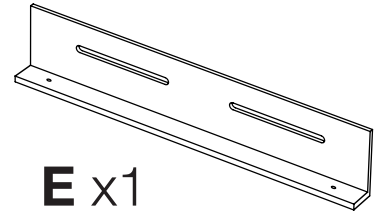
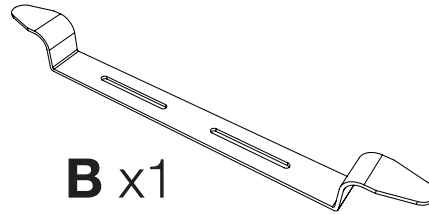
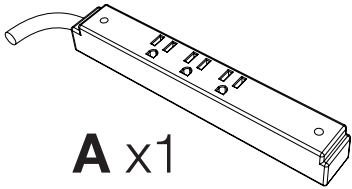
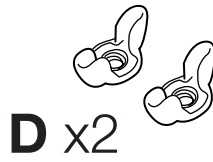
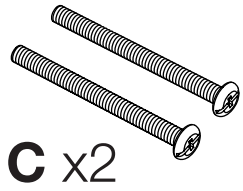
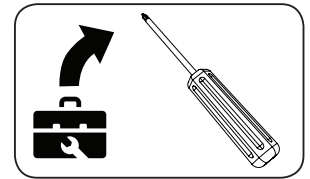

3 Flat Shelf 18 x 32 Cart w/ Cabinet Instructions

04/01/15

Parts List

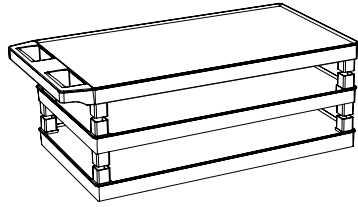

A x1
C x1
B x1

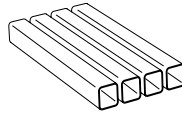

D x4

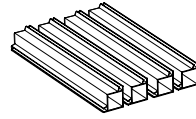

E x4

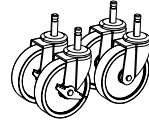

F x2
G x2

Tools Required

- Rubber Mallet
- Phillips Screwdriver



K x2

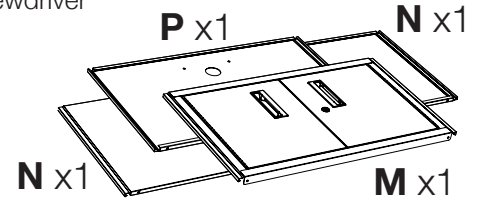

P x1
N x1
M x1

